



Dimanche 18 juillet 2010



Voiture balai 0496 50 48 06

<p>16</p> <p>Rue des Merises</p> <p>500 21000</p>	<p>20</p> <p>La Louveterie</p> <p>1400 23600</p>	<p>24</p> <p>19 STAVELOT</p> <p>4600 32700</p>
<p>15</p> <p>S.P.A.</p> <p>2100 20500</p>	<p>19</p> <p>400 22200</p>	<p>23</p> <p>TEIGE</p> <p>1200 28100</p>
<p>14</p> <p>E 42</p> <p>3300 18400</p>	<p>18</p> <p>Rue Beaudrifontaine</p> <p>DANGER</p> <p>700 21800</p>	<p>22</p> <p>SURISTER</p> <p>500 26900</p>
<p>13</p> <p>Place</p> <p>3600 15100</p>	<p>17</p> <p>100 21100</p>	<p>21</p> <p>JALHAY</p> <p>2800 26400</p>

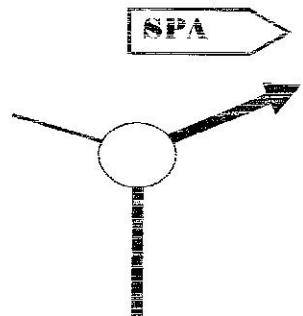
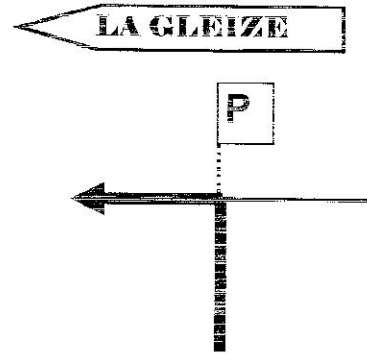
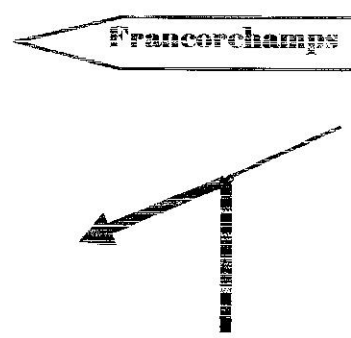
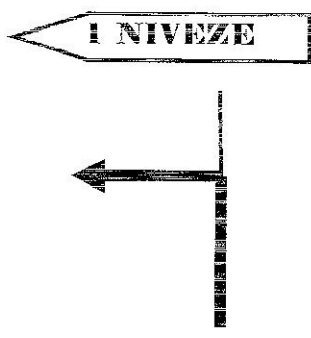
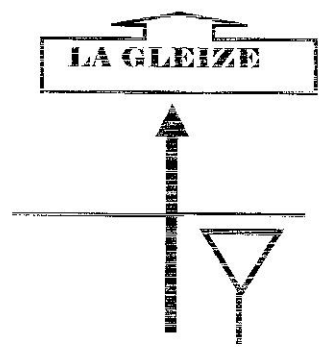
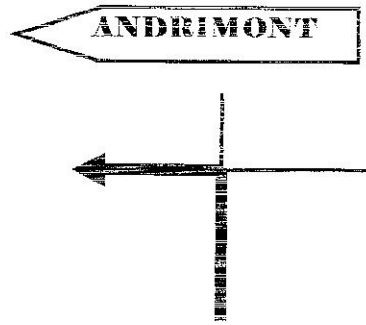
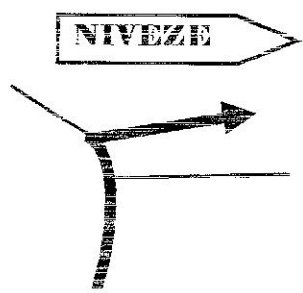
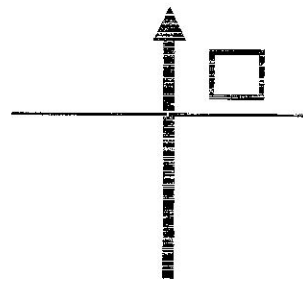
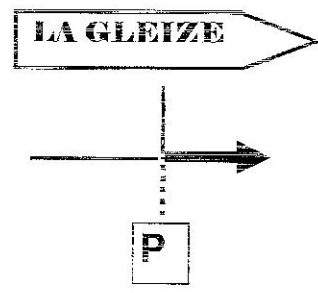
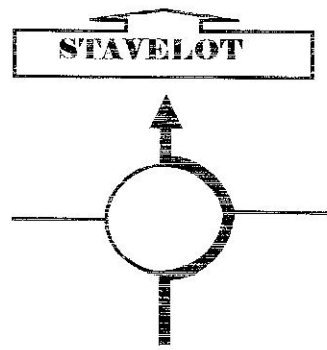
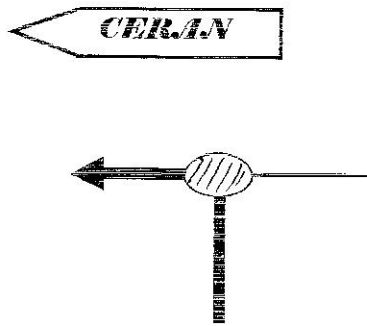

<p>28</p>  <p>1100 36000</p>	<p>32</p>  <p>2800 40300</p>	<p>36</p>  <p>3800 6700</p>
<p>27</p>  <p>1700 34900</p>	<p>31</p>  <p>600 37500</p>	<p>35</p>  <p>2900 2900</p>
<p>26</p>  <p>100 33200</p>	<p>30</p>  <p>400 36900</p>	<p>34</p>  <p>Remise des compteurs à zéro</p>
<p>25</p>  <p>400 33100</p>	<p>29</p>  <p>500 36500</p>	<p>33</p> <p>Arrêt graissage à la source de la Géronstère</p>

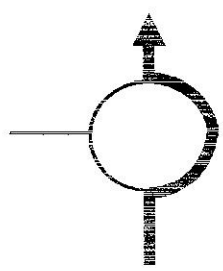
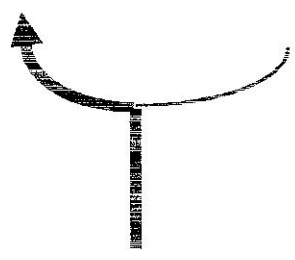
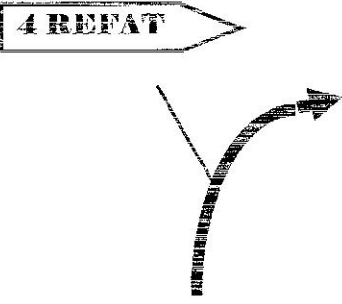
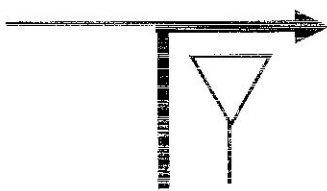
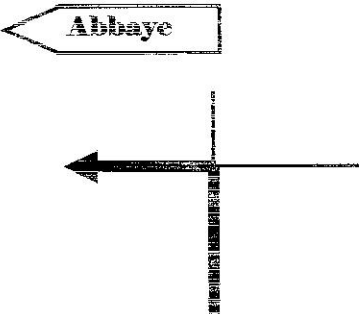

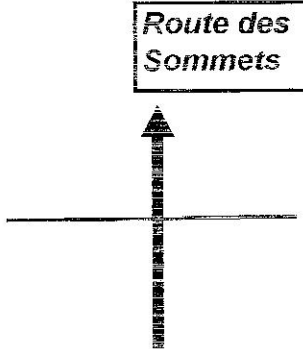
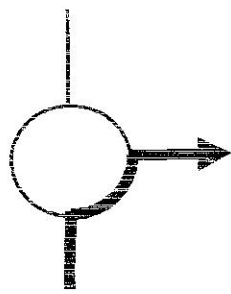
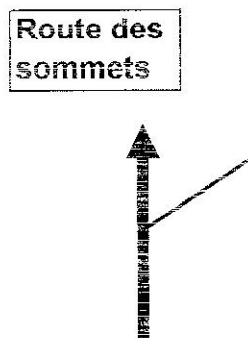
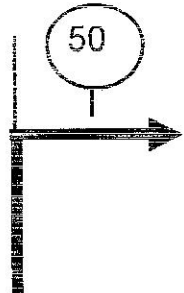
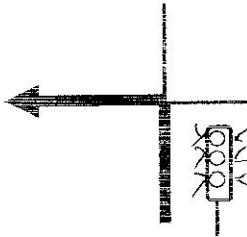
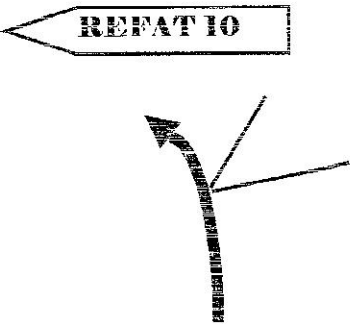





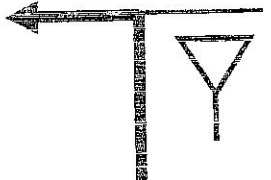
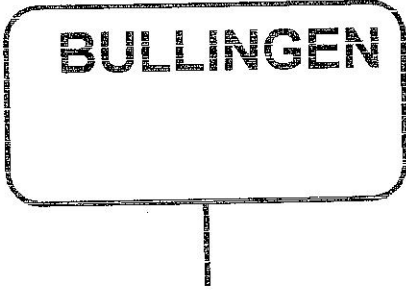

<p>40</p>  <p>2000 12300</p>	<p>44</p>  <p>200 15100</p>	<p>48</p> <p>4 REFAT</p>  <p>4400 20600</p>
<p>39</p>  <p>1200 10300</p>	<p>43</p> <p>Abbaye</p>  <p>300 14900</p>	<p>47</p> <p>Route des sommets</p>  <p>500 16200</p>
<p>38</p> <p>Route des Sommets</p>  <p>200 9100</p>	<p>42</p>  <p>200 14600</p>	<p>46</p> <p>Route des sommets</p>  <p>400 15700</p>
<p>37</p> <p>50</p>  <p>2200 8900</p>	<p>41</p>  <p>2100 14400</p>	<p>45</p> <p>REFATIO</p>  <p>200 15300</p>

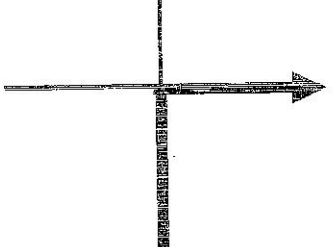

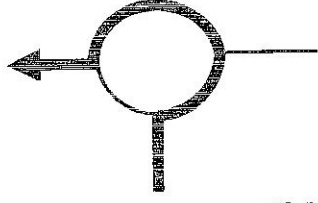

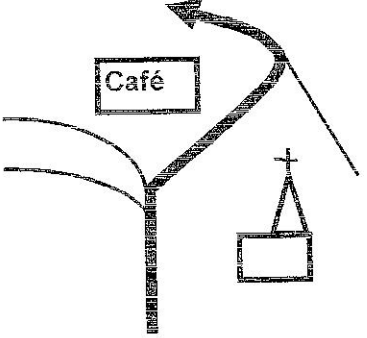

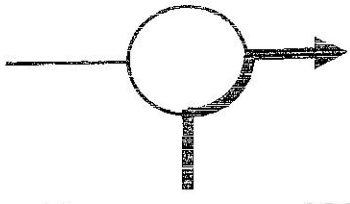
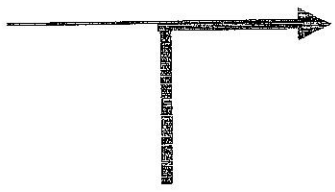
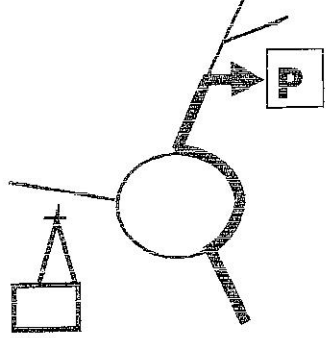
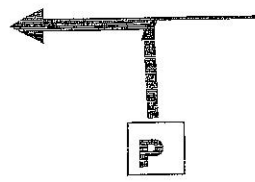
<p>52</p> <p>2800 28200</p>	<p>56</p> <p>3800 36500</p>	<p>60</p> <p>200 39500</p>
<p>51</p> <p>1100 25400</p>	<p>55</p> <p>2700 32700</p>	<p>59</p> <p>2100 39300</p>
<p>50</p> <p>2400 24300</p>	<p>54</p> <p>300 30000</p>	<p>58</p> <p>700 37200</p>
<p>49</p> <p>1300 21900</p>	<p>53</p> <p>1500 29700</p>	<p>57</p>

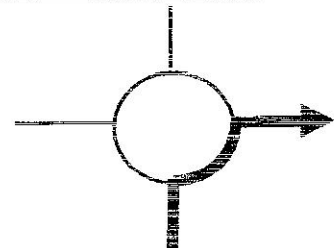
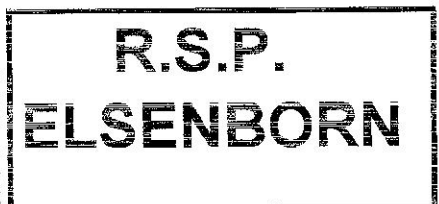

<p>64</p>  <p>1800 43000</p>	<p>68</p>	<p>72</p>  <p>400 8000</p>
<p>63</p>   <p>200 41200</p>	<p>67</p>	<p>71</p>   <p>7500 7600</p>
<p>62</p>   <p>1100 41000</p>	<p>66</p> <div data-bbox="606 1164 989 1489" style="border: 1px solid black; padding: 5px;"> <p><i>Arrêt pour le repas de midi. Restaurant Schröder Tel. 08054 88 25 Bon appétit.</i></p> </div>	<p>70</p>   <p>100 100</p>
<p>61</p>  <p>400 39900</p>	<p>65</p>  <p>9200 52200</p>	<p>69</p>  <div data-bbox="1037 1859 1460 1948" style="border: 1px solid black; padding: 5px;"> <p>Remise des compteurs à zéro</p> </div>

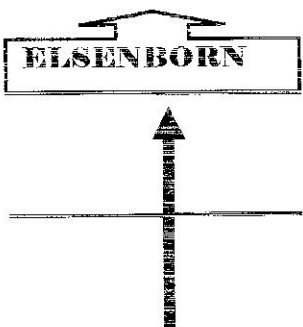
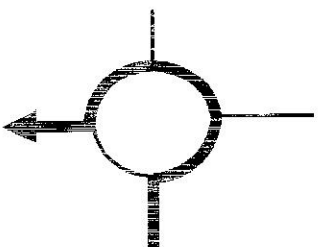
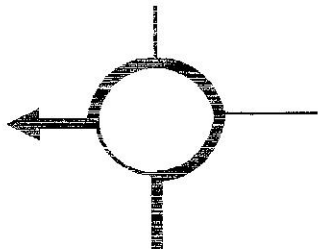

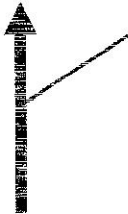
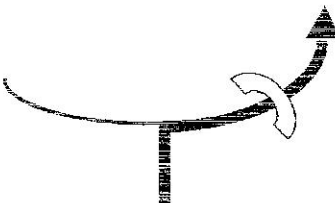
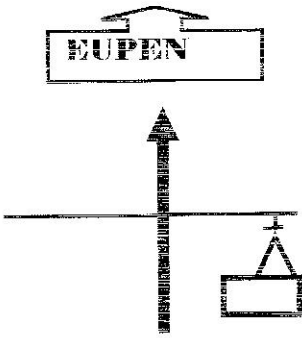

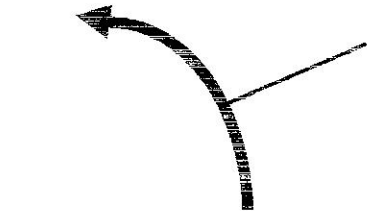
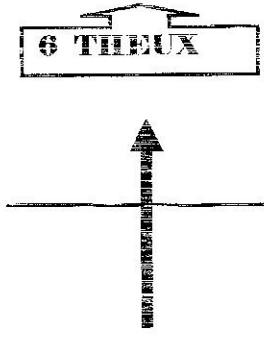
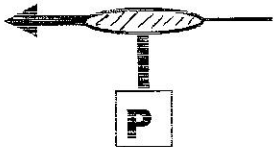
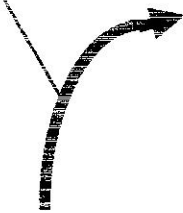
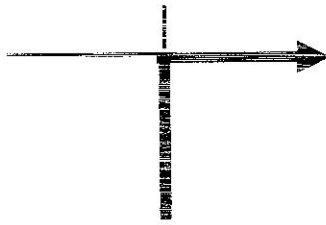
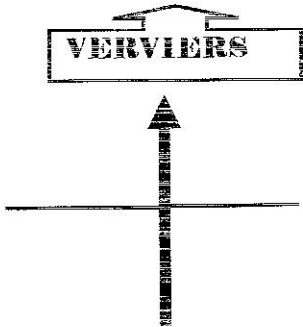
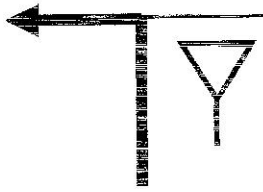
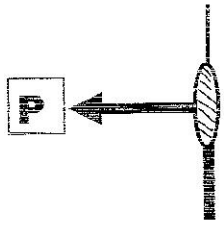
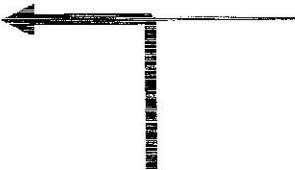
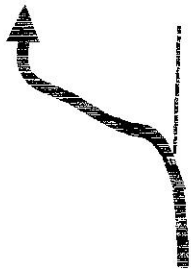

<p>76</p> <p>ROCHERBATH</p>  <p>300 20600</p>	<p>80</p> <p>R.S.P. ELSENBORN</p> 	<p>84</p> <p>VERVIERS 24</p>  <p>4100 36100</p>
<p>75</p> <p>BULLINGEN</p>  <p>6700 20300</p>	<p>79</p> <p>ELSENBORN</p>  <p>1400 23200</p>	<p>83</p> <p>SOURBRODT</p>  <p>3000 32000</p>
<p>74</p> <p>BÜLLINGEN</p>  <p>4200 13600</p>	<p>78</p> <p>5 ELSENBORN</p>  <p>1000 21800</p>	<p>82</p> <p>Station d'essence</p>  <p>1000 29000</p>
<p>73</p>  <p>1400 9400</p>	<p>77</p>  <p>200 20800</p>	<p>81</p> <p>EUPEN</p>  <p>4800 28000</p>



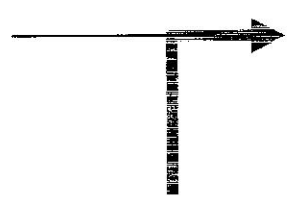
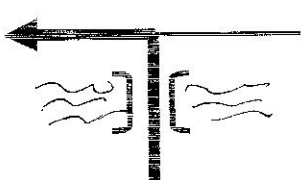
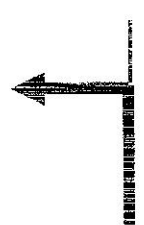
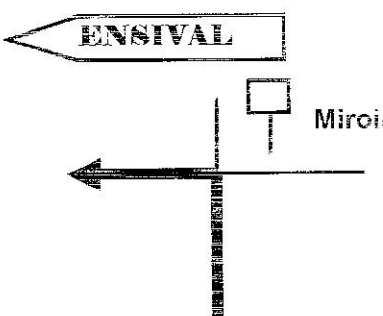
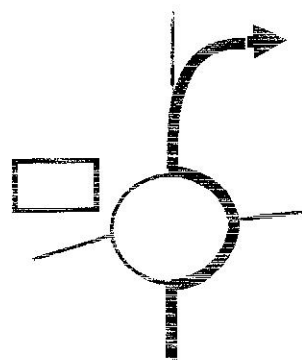
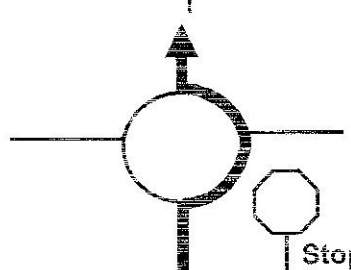

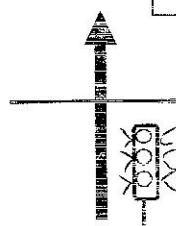
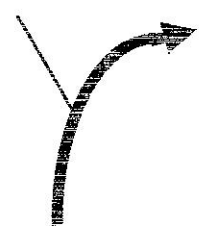

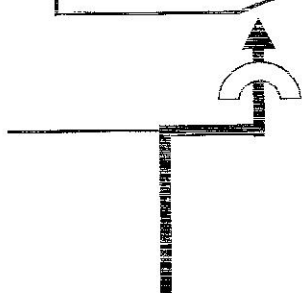
<p>88</p> <p>EUPEN</p>  <p>1600 1600</p>	<p>92</p> <p>THEUX</p>  <p>2500 15600</p>	<p>96</p> <p>THEUX</p>  <p>1400 19400</p>
<p>87</p>  <p>Remise des compteurs à zéro</p> <p>1500 13100</p>	<p>91</p> <p>VERVIERS 7</p>  <p>900 18000</p>	<p>95</p> <p>THEUX 8</p>  <p>6400 11600</p>
<p>86</p> <p>Arrêt graissage au Signal de Botrange Tél. 080 44 78 44</p> <p>6400 11600</p>	<p>90</p> <p>VERVIERS</p>  <p>400 17100</p>	<p>94</p> <p>THEUX</p>  <p>3400 39500</p>
<p>85</p> <p>P</p>  <p>3400 39500</p>	<p>89</p> <p>VERVIERS</p>  <p>3600 5200</p>	<p>93</p> <p>THEUX</p>  <p>1100 16700</p>

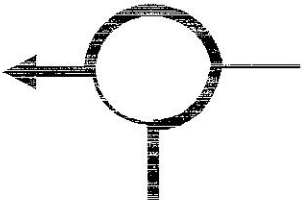

<p style="text-align: right;">100</p> <div style="border: 1px solid black; padding: 5px; text-align: center;"> <p>R.S.P.</p> <p>Golf du Haras</p> </div> <div style="border: 1px solid black; padding: 5px; margin-top: 10px;"> <p><i>Prudence route étroite !!!!</i></p> </div>	<p style="text-align: right;">104</p>  <p style="text-align: center;">200 25500</p>	<p style="text-align: right;">108</p>  <p style="text-align: center;">100 26200</p>
<p style="text-align: right;">99</p> <div style="border: 1px solid black; padding: 5px; text-align: center;"> <p>Ferme</p> </div>  <p style="text-align: center;">500 21600</p>	<p style="text-align: right;">103</p> <div style="border: 1px solid black; padding: 5px; text-align: center;"> <p>ENSIVAL</p> </div>  <p style="text-align: center;">500 25300</p>	<p style="text-align: right;">107</p>  <p style="text-align: center;">200 26100</p>
<p style="text-align: right;">98</p> <div style="border: 1px solid black; padding: 5px; text-align: center;"> <p><i>Drève de</i> Maison Bois</p> </div>  <p style="text-align: center;">1000 21100</p>	<p style="text-align: right;">102</p>  <p style="text-align: center;">1200 24800</p>	<p style="text-align: right;">106</p> <div style="border: 1px solid black; padding: 5px; text-align: center;"> <p>LIDL</p> </div>  <p style="text-align: center;">100 25900</p>
<p style="text-align: right;">97</p> <div style="border: 1px solid black; padding: 5px; text-align: center;"> <p>6 THEUX</p> </div>  <p style="text-align: center;">700 20100</p>	<p style="text-align: right;">101</p> <div style="border: 1px solid black; padding: 5px; text-align: center;"> <p>Golf</p> <p>Chemin du Haras</p> </div>  <p style="text-align: center;">2000 23600</p>	<p style="text-align: right;">105</p> <div style="border: 1px solid black; padding: 5px; text-align: center;"> <p>ENSIVAL</p> </div>  <p style="text-align: center;">300 25800</p>

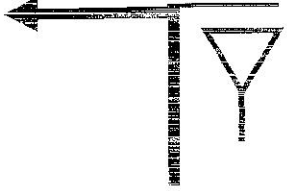
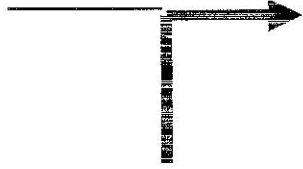

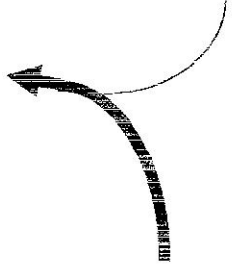
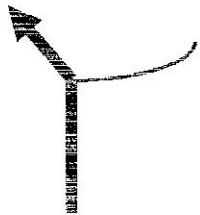
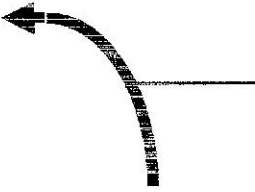
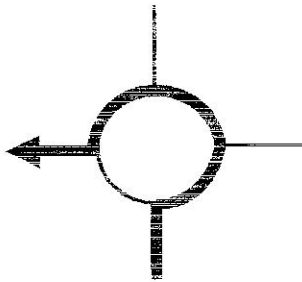
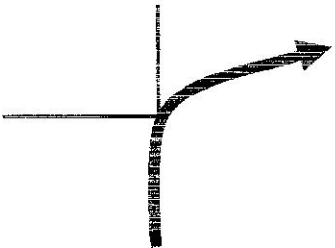
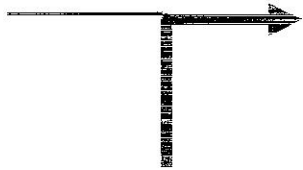
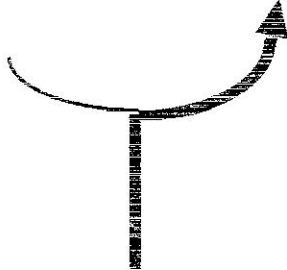
<p>112</p>  <p>400 27800</p>	<p>116</p>  <p>100 28700</p>	<p>120</p> <p>Grand-RECHAIN</p>  <p>1100 31400</p>
<p>111</p> <p>LAMBERMONT</p>  <p>600 27400</p>	<p>115</p>  <p>100 28600</p>	<p>119</p> <p>Grand-RECHAIN</p>  <p>400 30300</p>
<p>110</p> <p>LAMBERMONT</p>  <p>200 26800</p>	<p>114</p> <p>Petit-RECHAIN</p>  <p>200 28500</p>	<p>118</p> <p>Grand-RECHAIN</p>  <p>900 29900</p>
<p>109</p> <p>LAMBERMONT</p>  <p>400 26600</p>	<p>113</p>  <p>500 28300</p>	<p>117</p>  <p>300 29000</p>



Dimanche 18 juillet 2010

Voiture balai 0496 50 48 06

<p>124</p> <p>1400 36400</p>	<p>128</p>	<p>132</p>
<p>123</p> <p>1100 35000</p>	<p>127</p> <p>400 39000</p>	<p>131</p>
<p>122</p> <p>800 33900</p>	<p>126</p> <p>300 38600</p>	<p>130</p>
<p>121</p> <p>1700 33100</p>	<p>125</p> <p>1900 38300</p>	<p>129</p>